

# Hydra Storm

**DRAINAGE REINVENTED**

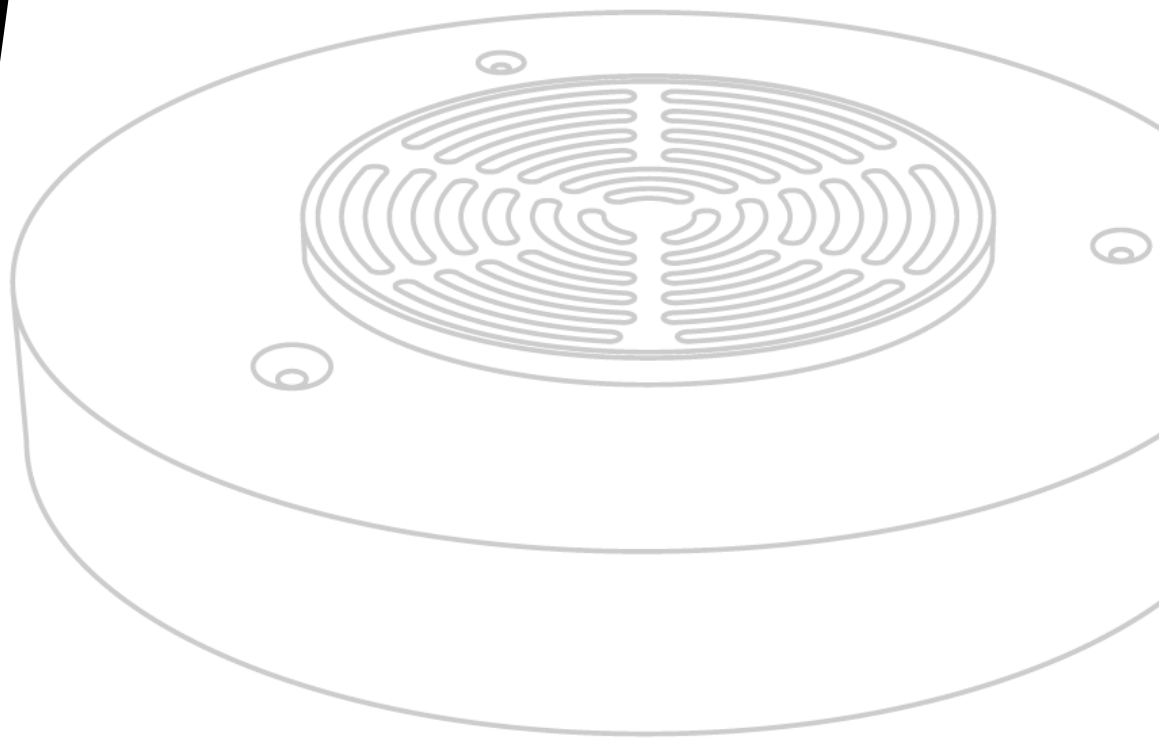

**PRECAST CATALOGUE**

VERSION 2

Sales (08) 9439 6077

[sales@hydrastorm.com.au](mailto:sales@hydrastorm.com.au)

[www.hydrastorm.com.au](http://www.hydrastorm.com.au)



---

**AT HYDRA STORM, WE HAVE NEARLY 20 YEARS  
EXPERIENCE IN SUPPLYING AND INNOVATING  
PRECAST SOLUTIONS. WITH THE EXPERIENCE OF  
THE PAST AND AN EYE TO THE FUTURE, WE'RE  
DELIVERING TODAY.**

---

Over time the business has expanded to service a broad range of civil and mining contractors, commercial plumbers, local government councils and regulatory authorities.

Hydra Storm manufactures a diversified range of sewerage, drainage and made-to-order custom precast components from a specialised facility in the Kwinana Industrial area.

Hydra Storm offers value to clients with high quality products and exceptional customer service.



# CONTENTS

**05 Sewer  
Manhole Bases**

---

**Sewer Conversion Slabs  
& Make Up Pieces**

---

**06 Sewer  
Manhole Covers**

---

**Encased  
PVC Bends**

---

**07 Stormwater  
Gully Bases**

---

**08 Stormwater  
Manhole Covers**

---

**09 Class D Stormwater  
Manhole Covers**

---

**10 Class D Cast Iron  
Grated Covers**

---

**11 Stormwater Gully  
Grated Covers**

---

**14 Side Entry  
Components**

---

**15 Spacer Rings, Headwalls  
& Conversion Slabs**

---

**16 Main Roads  
WA Covers**

---

**17 Custom Precast  
Products**

---

## Sewer

### Manhole Bases

Hydra Storm manufactures a range of sewer products and are approved to supply complete components for Type 1 Access Chambers to Water Corporation WA specifications.

Manhole Bases are available blank or fully benched to individual sewer reticulation drawings.



CODE	DESCRIPTION	WEIGHT (KG)
S01	Type 1 Sewer Manhole Base - Blank	840
S02	Type 1 Sewer Manhole Base - Benched	1165

## Sewer Conversion Slabs

### & Make up Pieces

Hydra Storm Sewer Conversion Slabs and Make-up Pieces are a cost effective and efficient alternative to traditional brick makeups.

Available in two standard sizes to allow manhole height adjustment to suit site requirements.

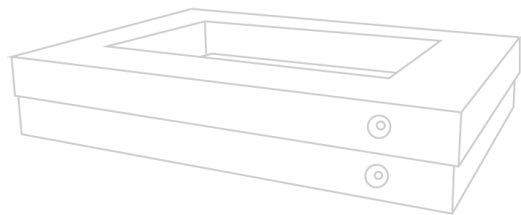

CODE	DESCRIPTION	WEIGHT (KG)
S04	Sewer Conversion Slab (Suit 900x600 2 part)	562
S05-100	Rectangular Spacer 1430x1070x100mm (SUIT 2pt Class D)	221
S05-150	Rectangular Spacer 1430x1070x150mm (SUIT 2pt Class D)	330

## Sewer

### Manhole Covers

Hydra Storm sewer manhole covers are fully approved by Water Corporation WA and are available in Flush or Raised profile to suit your requirements.

Also available in solid-top cast iron or concrete infill case iron options.

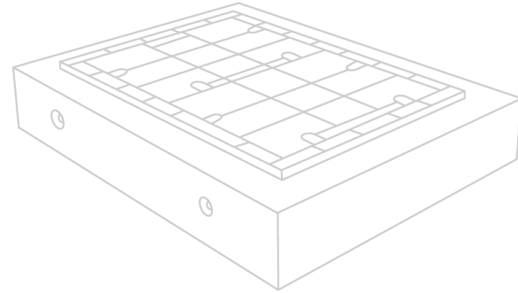

CODE	DESCRIPTION	WEIGHT (KG)
S11	2pt Cast Iron Sewer Cover - Flush	630
S12	2pt Cast Iron Sewer Cover - R25mm	693
S13	2pt Cast Iron Sewer Cover - R100mm	758

## Encased

### PVC Bends

Hydra Storm supply a full range of encased PVC Sewer Bends. These remove the need for casting a concrete in-situ and offer significant time and resource savings on site.

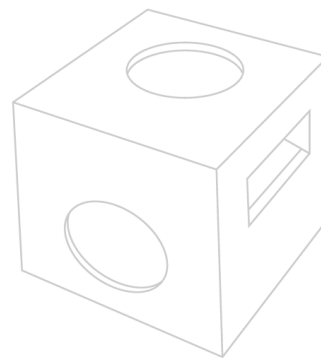

CODE	DESCRIPTION	WEIGHT (KG)
S16	Encased 100mm 90 deg. Bend	32
S17	Encased 150mm 90 deg. Bend	86
S18	Encased IS 150mm 90 deg. Bend	220
S20P8L	P8 Sewer Junction 150x100x60 deg. Encased - Left	184
S20P8R	P8 Sewer Junction 150x100x60 deg. Encased - Right	184
S225P8L	P8 Sewer Junction 225x100x60° Encased - Left	338
S225P8R	P8 Sewer Junction 225x100x60° Encased - Right	338

## Stormwater

### Gully Bases

Hydra Storm stormwater bases are available to suit liners and soakwells of all sizes and are available as a solid slab, or with a range of weephole sizes.

We can also cast custom sizes to suit any requirement.

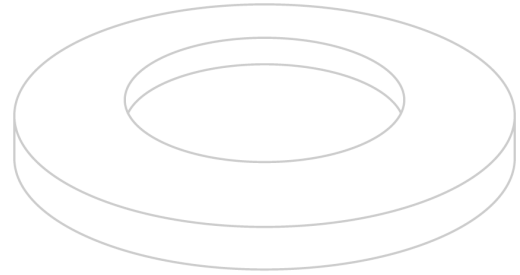

CODE	DESCRIPTION	WEIGHT (KG)
SW01	1200 Dia. X 150mm Gully Base - 150 hole	398
SW01B	1200 Dia. X 150mm Gully Base - 600 hole	310
SW01S	1200 Dia. X 150mm Gully Base - Solid	412
SW02	1300 Dia. X 150mm Gully Base - 150 hole	475
SW02B	1300 Dia. X 150mm Gully Base - 600 hole	390
SW02S	1300 Dia. X 150mm Gully Base - Solid	480
SW03	1400 Dia. X 150mm Gully Base - 150 hole	550
SW03B	1400 Dia. X 150mm Gully Base - 600 hole	465
SW03S	1400 Dia. X 150mm Gully Base - Solid	558
SW04	1750 Dia. X 150mm Gully Base - 600 hole	687
SW04S	1750 Dia. X 150mm Gully Base - SOLID	699
SW05	2000 Dia. X 150mm Gully Base - 600 hole	1015
SW05S	2000 Dia. X 150mm Gully Base - SOLID	1150
SW05SF	2000 Dia. X 150mm Strip Footing	723



## Stormwater

### Manhole Covers

Hydra Storm manhole and junction pit covers come with circular concrete inserts to suit all liner sizes.

These covers are designed for use in verges and are used extensively in local government councils throughout WA.

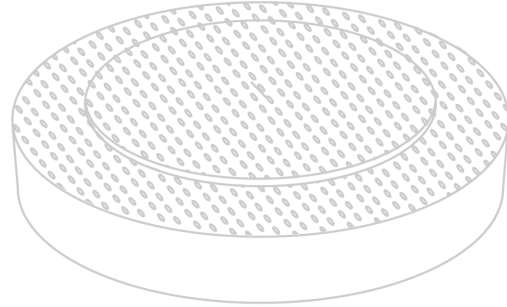

CODE	DESCRIPTION	WEIGHT (KG)
SW06	1050 Dia. Manhole Cover w/- concrete insert	265
SW07	1050 X 1050 Manhole Cover w/- concrete insert	323
SW08	1200 Dia. Manhole Cover w/- concrete insert	355
SW09	1200 x 1200 Manhole Cover w/- concrete insert	455
SW10	1400 Dia. Manhole Cover w/- concrete insert	498
SW11	1350 x 1350 Manhole Cover w/- concrete insert	597
SW12	1650 Dia. Manhole Cover w/- concrete insert	714
SW13	2050 Dia. Soakwell Manhole Cover w/- concrete insert	1004
SW14	Stormwater Cover insert - 750 x 75mm	80

## Class D Stormwater

### Manhole Covers

Hydra Storm manhole and junction pit covers come with Class D cast iron inserts to suit all liner sizes.

These covers are designed for use in roadways and are available in flush or in various raised profiles.

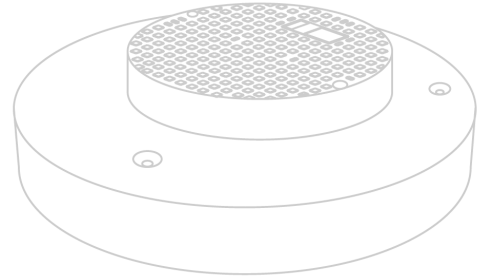

CODE	DESCRIPTION	WEIGHT (KG)
SW15	600 Dia. Cast iron Cover - 1200 surround - Flush	470
SW16	600 Dia. Cast iron Cover - 1200 surround - R25	470
SW17	600 Dia. Cast iron Cover - 1200 surround - R100	475
SW18	600 Dia. Cast iron Cover - 1400 surround - Flush	670
SW18R25	600 Dia. Cast iron Cover - 1400 surround - R25	670
SW18R100	600 Dia. Cast iron Cover - 1400 surround - R100	675
SW19	600 Dia. Cast iron Cover - 1650 surround - Flush	895
SW19R25	600 Dia. Cast iron Cover - 1650 surround - R25	895
SW19R100	600 Dia. Cast iron Cover - 1650 surround - R100	890
SW20	600 Dia. Cast iron Cover - 2000 surround - Flush	1400
SW20R25	600 Dia. Cast iron Cover - 2000 surround - R25	1400
SW20R100	600 Dia. Cast iron Cover - 2000 surround - R100	1394

## Class D Cast Iron

### Grated Covers

Hydra Storm Sewer Circular Cast Iron grated covers are manufactured to suit Class D heavy loads.

Cast in a range of sizes to suit all liner and Soakwell diameters.

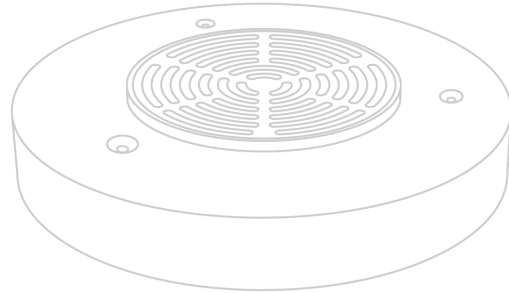

CODE	DESCRIPTION	WEIGHT (KG)
SW21	600 Dia. Cast iron Cover - 1200 surround - Flush	470
SW22	600 Dia. Cast iron Cover - 1200 surround - R25	470
SW23	600 Dia. Cast iron Cover - 1200 surround - R100	475
SW24	600 Dia. Cast iron Cover - 1400 surround - Flush	670
SW24R25	600 Dia. Cast iron Cover - 1400 surround - R25	670
SW24R100	600 Dia. Cast iron Cover - 1400 surround - R100	675
SW25	600 Dia. Cast iron Cover - 1650 surround - Flush	895
SW25R25	600 Dia. Cast iron Cover - 1650 surround - R25	895
SW25R100	600 Dia. Cast iron Cover - 1650 surround - R100	890
SW26	600 Dia. Cast iron Cover - 2000 surround - Flush	1050
SW26R25	600 Dia. Cast iron Cover - 2000 surround - R25	1050
SW26R100	600 Dia. Cast iron Cover - 2000 surround - R100	1137

## Stormwater Gully Grated

### Covers

Hydra Storm stormwater gully grated covers are available in a wide range of configurations to suit your requirements. These covers come in flush or various raised profiles to suit your requirements.

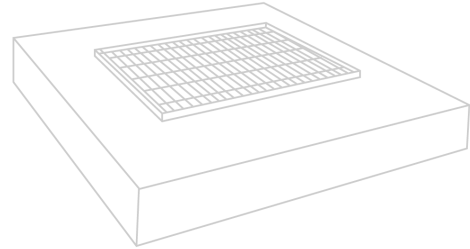

CODE	DESCRIPTION	WEIGHT (KG)
SW27	1050x1050x150mm Cover w/- Class D Wave Grate	286
SW27R25	Std Gully Grate - 1050x1050x150mm - R25	286
SW28	Std Galv Grate - 1200x1200x150mm - Flush	440
SW28R25	Std Gully Grate - 1200x1200x150mm - R25	440
SW28R100	Std Gully Grate - 1200x1200x150mm - R100	450
SW28BU	Std Gully Grate - 1200x1200x150mm - Bubble Up	480
SW28V	Std "V" Grate - 1200x1200x150mm - R25	580
SW31	Std Gully Grate - 1350x1350x150mm - Flush	580
SW31R25	Std Gully Grate - 1350x1350x150mm - R25	580
SW31R100	Std Gully Grate - 1350x1350x150mm - R100	580
SW31BU	Std Gully Grate - 1350x1350x150mm - Bubble Up	598
SW31V	Std "V" Grate - 1350x1350x150mm - R25	765

## Stormwater Gully Grated

### Covers *(continued)*

Hydra Storm stormwater gully grated covers are available in a wide range of configurations to suit your requirements. These covers come in flush or various raised profiles to suit your requirements.

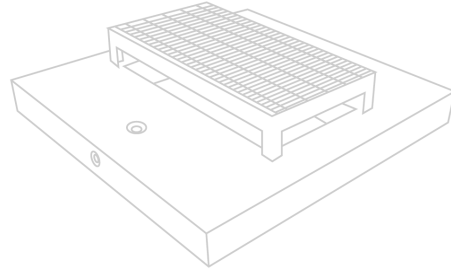

CODE	DESCRIPTION	WEIGHT (KG)
SW34	Industrial Gully Grate - 1350x1350x150mm - Flush	575
SW34R25	Industrial Gully Grate - 1350x1350x150mm - R25	575
SW34R100	Industrial Gully Grate - 1350x1350x150mm - R100	580
SW34BU	Industrial Gully Grate - 1350x1350x150mm - Bubble Up	590
SW34V	Industrial "V" Grate - 1350x1350x150mm - R25	620
SW37	Std Gully Grate - 1650 dia. x 150mm - Flush	710
SW37R25	Std Gully Grate - 1650 dia. x 150mm - R25	710
SW37R100	Std Gully Grate - 1650 dia. x 150mm - R100	720
SW37BU	Std Gully Grate - 1650 dia. x 150mm - Bubble Up	720
SW37V	Std "V" Grate - 1650 dia. x 150mm - R25	930
SW39	Class D Wave Grate - 2050 dia. x 150mm - Flush	1030
SW39R25	Std Gully Grate - 2050 dia. x 150mm - R25	1030
SW39R100	Std Gully Grate - 2050 dia. x 150mm - R100	1040
SW38BU	Std Gully Grate - 2050 dia. x 150mm - Bubble Up	1080

## Stormwater Wave Gate

### Covers

Hydra Storm stormwater gully grated covers are available in a wide range of configurations to suit your requirements. These covers come in flush or various raised profiles to suit your requirements.

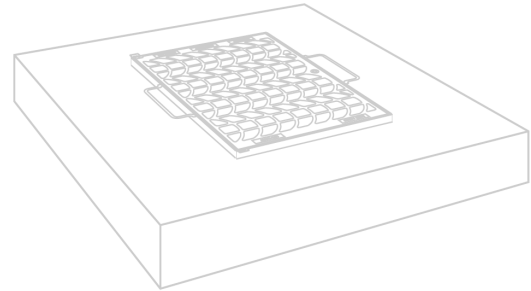

CODE	DESCRIPTION	WEIGHT (KG)
SW27HD	1050x1050x150mm Cover w/- Class D Wave Gate	350
SW27R25	1050x1050x150mm Cover w/- Wave Gate R25	350
SW27R100	1050x1050x150mm Cover w/- Wave Gate R100	352
SW32	1200x1200x150mm Cover w/- Wave Gate Flush	467
SW32R25	1200x1200x150mm Cover w/- Wave Gate R25	467
SW32R40	1200x1200x150mm Cover w/- Wave Gate R40	467
SW32R100	1200x1200x150mm Cover w/- Wave Gate R100	480
SW35	1350x1350x150mm Cover w/- Wave Gate Flush	467
SW35R25	1350x1350x150mm Cover w/- Wave Gate R25	580
SW35R40	1350x1350x150mm Cover w/- Wave Gate R40	580
SW35R100	1350x1350x150mm Cover w/- Wave Gate R100	585
SW35IND	1350x1350x150mm Cover w/- Industrial Wave Gate R25	575
SW38R25	1750 Dia. x 150mm Cover w/- Wave Gate R25	710
SW38R100	1750 Dia. x 150mm Cover w/- Wave Gate R100	720
SW39	2050 Dia. x 150mm Cover w/- Class D Wave Gate Flush	1090
SW39WR25	2050 dia. x 150mm Cover w/- Class D Wave Gate R25	1090
SW39WR40	2050 dia. x 150mm Cover w/- Class D Wave Gate R40	1090
SW39WR100	2050 dia. x 150mm Cover w/- Class D Wave Gate R100	1095

## Side Entry Pits & Components

Hydra Storm manufactures a full range of Side Entry components to suit all Local Govt authorities as well as to MRWA specifications.

Covers are designed to tie into kerb lines to create a seamless and functional solution.

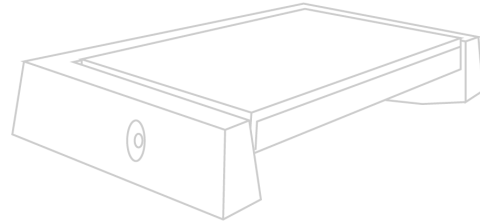

CODE	DESCRIPTION	WEIGHT (KG)
SW40	Combination Side Entry Pit Cover - Flush	630
SW40R25	Combination Side Entry Pit Cover - R25	630
SW40WF	Combination SEP Cover w/- Wave Grate - Flush	650
SW40WR25	Combination SEP Cover w/- Wave Grate - R25	650
SW40WR40	Combination SEP Cover w/- Wave Grate - R40	650
SW41	Universal Side Entry Pit RH Deflector Slab	737
SW42	Universal Side Entry Pit LH Deflector Slab	737
SW43	Universal Side Entry Pit Plain Deflector Slab	737
SW44	Universal Side Entry Pit Frame	126
SW45	Universal Side Entry Pit Lid	85
SW46	Cockburn Apron	518
SW47	Cockburn Semi- Mountable Cover w/- concrete insert	412
SW48	Cockburn Barrier Cover w/- concrete insert	412

## Spacer Rings, Headwalls & Conversion Slabs

Hydra Storm Spacer Rings offer an effective and efficient way to adjust pit levels to required heights. We also manufacture standard conversion slabs and headwalls to suit a variety of liner and pipe sizes.

Hydra Storm can custom manufacture variances of these products to suit your requirements.

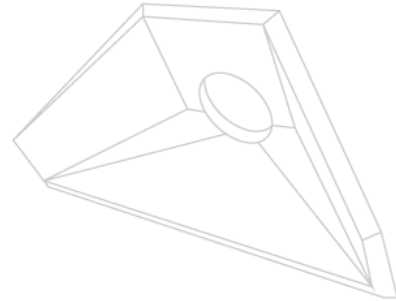

CODE	DESCRIPTION	WEIGHT (KG)
SW51-100	Spacer Rings suit 940 liner - 100mm deep	60
SW51-150	Spacer Rings suit 940 liner - 150mm deep	90
SW52-100	Spacer Rings suit 1090 liner - 100mm deep	76
SW52-150	Spacer Rings suit 1090 liner - 150mm deep	114
SW53-100	Spacer Rings suit 1240 liner - 100mm deep	108
SW53-150	Spacer Rings suit 1240 liner - 150mm deep	162
SW57-300	Headwall to suit 300 pipe	385
SW57-375	Headwall to suit 375 pipe	385
SW57-450	Headwall to suit 450 pipe	385
CS01	1650 Dia. x 200mm w/- 900mm Offset Opening	691
CS02	2050 Dia. x 200mm w/- 900mm Offset Opening	1160
SW56	Lineal Soakage Unit	635
SW56B	Lineal Soakage Unit - Lid	365



## Main Roads

### WA Covers

Hydra Storm MRWA covers are made in accordance with Main Roads requirements and are suitable for trafficable and non-trafficable applications.

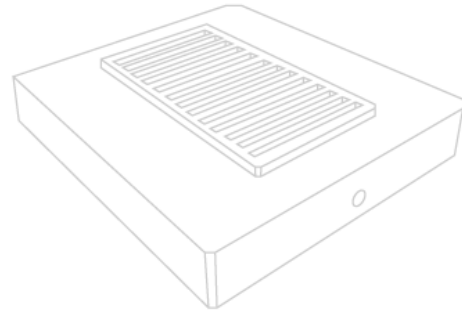

CODE	DESCRIPTION	WEIGHT (KG)
M01	GN Cover - 1500x1300x200mm w/- Galv MRWA Grate Flush	884
M02	GT Cover - 1500x1300x230mm w/- Galv MRWA Grate - R4	985
M03	GT Cover - 1650x230mm w/- Galv MRWA Grate - R40	1109
M04	WN Cover - 1500x1300x200mm w/- 2x Concrete Lids	810
M05	WT Cover - 1500x1300x230mm 2pt Class D R-40mm	990
M06	HN Cover -1650x200 Catchpit Grate	944
M07	RT Cover - 1500x1300x230mm w/- 600 Dia. Class D - R40	1045
M08	HN Cover - 1500x1300x200mm w/- Catchpit Grate	866
M09	RN Cover - 1500x1300x200mm w/- Concrete Insert	892
M10	WT Cover - 1660 Dia. x 230mm 2pt Class D R-40mm	972
M11	RT Cover - 1660 Dia. x 230mm w/- 600 Dia. Class D - R40	1088

## CUSTOM PRECAST PRODUCTS

Over the last 20 years Hydra Storm has fabricated thousands of custom solutions to meet site and job specific requirements. From custom Lids and Bases, to Pipe Support and Anchor Blocks, Pump Skid Plates, Cable Pits and Boom Gate Foundations, we have you covered!

Call or email us today to discuss your custom requirements.

08 9439 6077

[sales@hydrastorm.com.au](mailto:sales@hydrastorm.com.au)

### Reilly Contractors - Yanchep Sewer Main Covers







12-13 Butcher Street

Rwinana WA 6167

Sales: (08 9439 6077

[sales@hydrastorm.com.au](mailto:sales@hydrastorm.com.au)

[www.hydrastorm.com.au](http://www.hydrastorm.com.au)